

CC-Link IE TSN Product Catalog

e-Factory



CC-Link **IE** TSN

GLOBAL IMPACT OF MITSUBISHI ELECTRIC



Through Mitsubishi Electric's vision, "Changes for the Better" are possible for a brighter future.

Changes for the Better

We bring together the best minds to create the best technologies. At Mitsubishi Electric, we understand that technology is the driving force of change in our lives. By bringing greater comfort to daily life, maximizing the efficiency of businesses and keeping things running across society, we integrate technology and innovation to bring changes for the better.

Mitsubishi Electric is involved in many areas including the following

Energy and Electric Systems

A wide range of power and electrical products from generators to large-scale displays.

Electronic Devices

A wide portfolio of cutting-edge semiconductor devices for systems and products.

Home Appliance

Dependable consumer products like air conditioners and home entertainment systems.

Information and Communication Systems

Commercial and consumer-centric equipment, products and systems.

Industrial Automation Systems

Maximizing productivity and efficiency with cutting-edge automation technology.

Committed to ever-higher customer satisfaction

Mitsubishi Electric is a global leader in researching, manufacturing and marketing electrical and electronic equipment used in areas such as communications, consumer electronics, industrial technology, energy and transportation. Within this, the industrial automation business has grown significantly since the first induction motor was manufactured over 90 years ago and has closely followed the automation industry in Japan, Asia, and beyond. Mitsubishi Electric industrial automation boasts a wide range of product areas such as production control, drives, and mechatronics that are used in various industries. The company also offers e-F@ctory and iQ Platform, leveraging its total industrial automation solution portfolio.



Realizing a smart factory with an open integrated network

Creating a smart factory requires the real-time collection of shop floor data, utilizing edge-computing devices to enable point-of-origin processing, and instantaneously feeding back results to the processing machine, cloud or other IT systems. This must all be done over a robust, high-speed network having a large-capacity data bandwidth capable of transmitting large volumes of data seamlessly across the factory while maintaining deterministic control of all systems. Mitsubishi Electric products provide the interconnectivity required for entire factories to realize IIoT*1 infrastructures, simultaneously improving productivity and quality while reducing overall cost.

*1. IIoT: Industrial Internet of Things

INDEX

Features.....	8
System configuration	14
Master station	16
Slave station	
Drives/GOT (HMI).....	18
Slave station	
Block-type remote modules	20
Development tools	24

The contents described in this catalog include features that will be supported in the future. Specifications may change without prior notice.

e-F@ctory

Maximize productivity and reduce costs with an intelligent smart factory solution

Intelligent smart factories utilize high-speed networks with large data bandwidths to meet current manufacturing needs. The combination of CC-Link IE TSN and Mitsubishi Electric's e-F@ctory solution ensures robust integration between IT and factory automation systems, providing an intelligent smart factory solution that reduces total cost while improving operations, production yield, and efficient management of the supply chain. e-F@ctory is the Mitsubishi Electric solution for adding value across the manufacturing enterprise by enhancing productivity, thereby simultaneously reducing maintenance and operating costs, and enabling the seamless flow of information throughout the plant. e-F@ctory uses a combination of factory automation and IT technologies in combination with various best-in-class partner products through its alliance program.

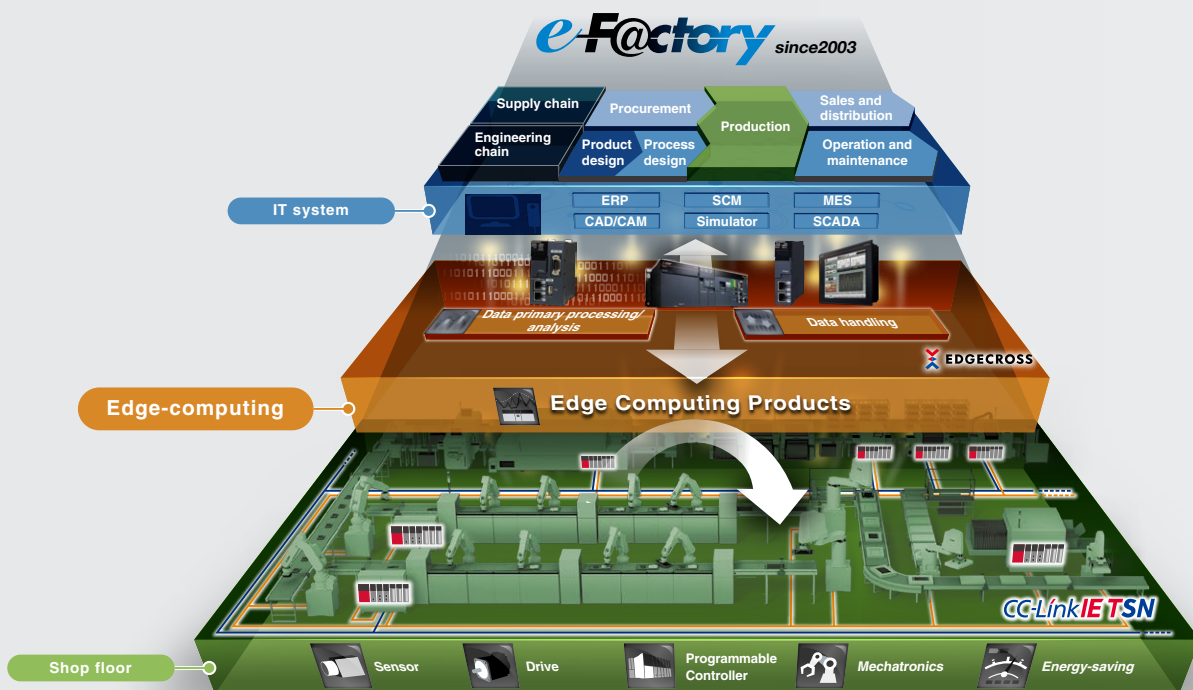

e-F@ctory

CC-Link IE TSN

- IT integration
- High speed, Time synchronization
- Open technology
- Network integration

MELSEC iQ-R MITSUBISHI ELECTRIC SERVO SYSTEM MELSERVO-J5 FREQROL-A800 GOT2000 MELFA FR MITSUBISHI ELECTRIC CNC C80

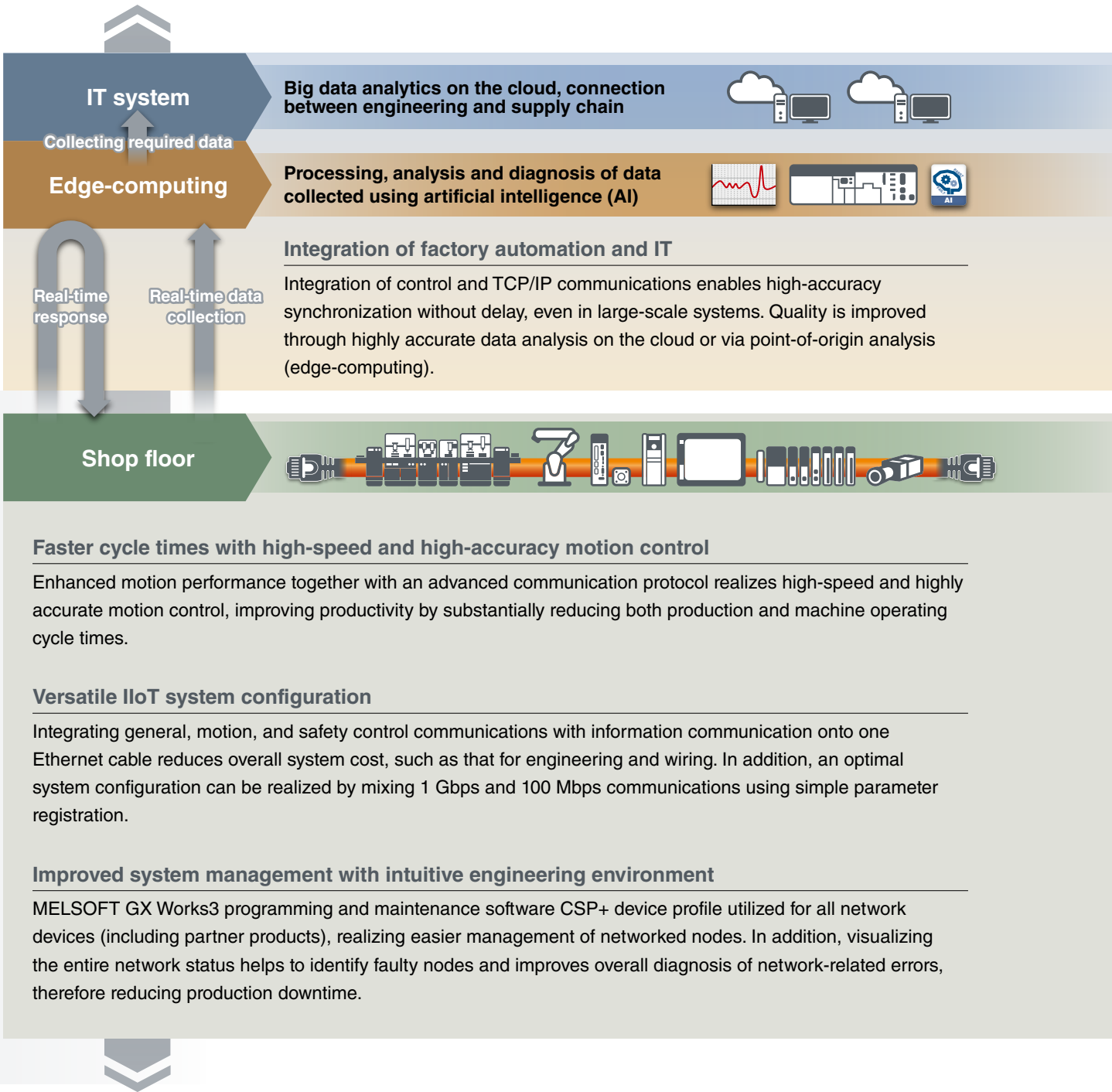

Open integrated networking across the manufacturing enterprise

Leveraging an integrated and open network utilizing TSN technology realizes real-time data collection from the shop floor to IT systems

CC-Link IE TSN supports TCP/IP communications and applies it to industrial architectures through its support of TSN enabling real-time communications. With its flexible system architecture and extensive setup and troubleshooting features make CC-Link IE TSN ideal for building an IIoT infrastructure across the manufacturing enterprise.

* TSN: Time Sensitive Networking
 * IIoT: Industrial Internet of Things

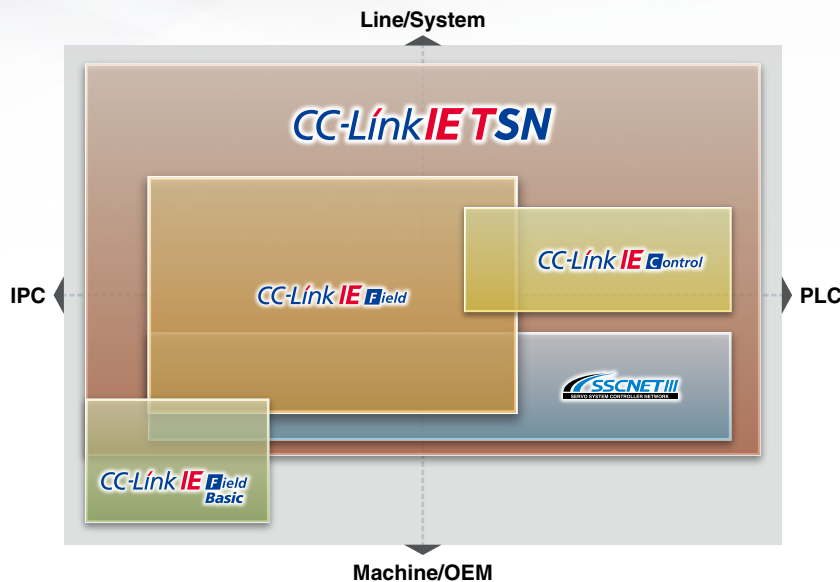

CC-Link IE TSN is an open industrial network inheriting the easy diagnostics of the CC-Link IE Field Network, the large-capacity data communications of the CC-Link IE Control Network, and the high-performance motion control features of SSCNET. Through the incorporation of TSN technology, this network further leverages control system performance to realize an open integrated network with advanced functionality.



CC-Link IE TSN
"IIoT system" movie



CC-Link IE TSN
"Integrated motion" movie

What is Time-Sensitive Networking (TSN)?

TSN is the IEEE-defined standard technology that enables deterministic messaging on standard Ethernet. The technology ensures deterministic communications by utilizing the time synchronization method (IEEE 802.1AS) and time-sharing method (IEEE 802.1Qbv). With the addition of these standards to Ethernet technology, real-time control communication and non-real time information communication can be mixed, which is not possible with conventional Ethernet communications.

TSN Technology

: Features utilizing TSN technology

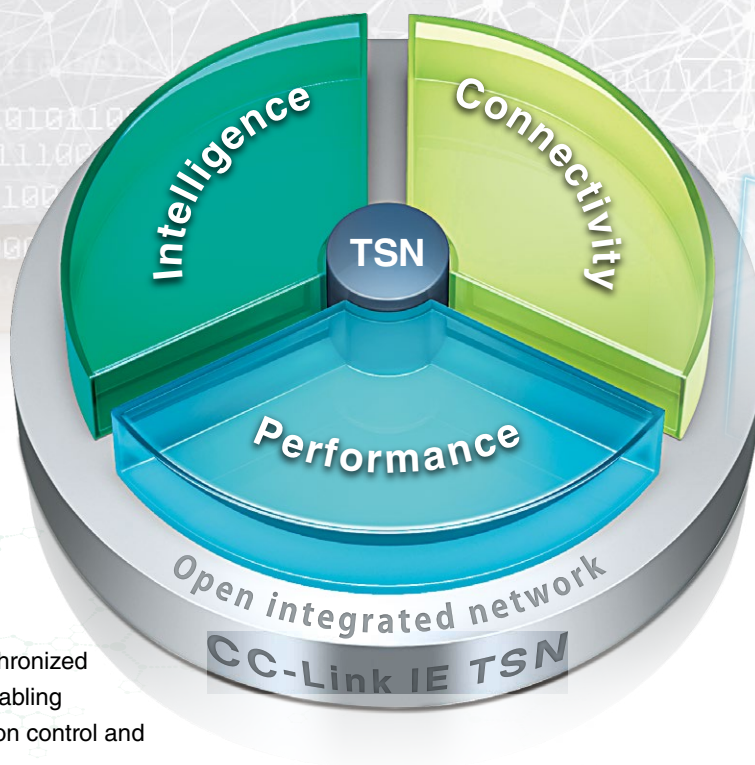

Real-time and synchronized communications enabling high-accuracy motion control and event processing

Performance

Current manufacturing trends are utilizing AI and predictive maintenance to ensure high productivity and quality are achieved simultaneously. This requires high-speed communication and deterministic control of large volumes of data to IT systems. The innovative communication technology of CC-Link IE TSN increases communication performance, enables highly accurate motion control and high-speed I/O control without adversely affecting operating performance.

Intelligence

Intelligent networks that support industrial communications to realize easy device setup and preventive maintenance are essential for efficient operations. CC-Link IE TSN supports third-party diagnostic software, enabling troubleshooting of network devices (including standard Ethernet). Network event errors are time-stamped, enabling the actual cause of error to be easily evaluated. In addition, automatic generation of network system architectures and parameters simplifies commissioning.

Connectivity

CC-Link IE TSN is the key to realizing real-time communication in manufacturing systems utilizing TCP/IP-compatible Ethernet-based networks. It also enables third-party networks and standard Ethernet devices such as vision sensors and wireless routers to be integrated, and has multiple topology possibilities in support of highly scalable and flexible system architectures.



Performance

Reducing overall operating time with high-speed link scan

Min. communication cycle **31.25^{*1} μs**

High-speed processing **16^{*2} x** faster

Link points **2^{*3} x**

The advanced protocol built into CC-Link IE TSN is complemented by the time-sharing method functionality that enables bidirectional communications between network stations. This realizes fast communication cycle time of just 31.25 μs and high-speed processing 16 times faster than current network performance, resulting in high-speed, highly accurate motion control. Productivity is simultaneously improved owing to a substantial increase in control performance, which reduces overall operating time.

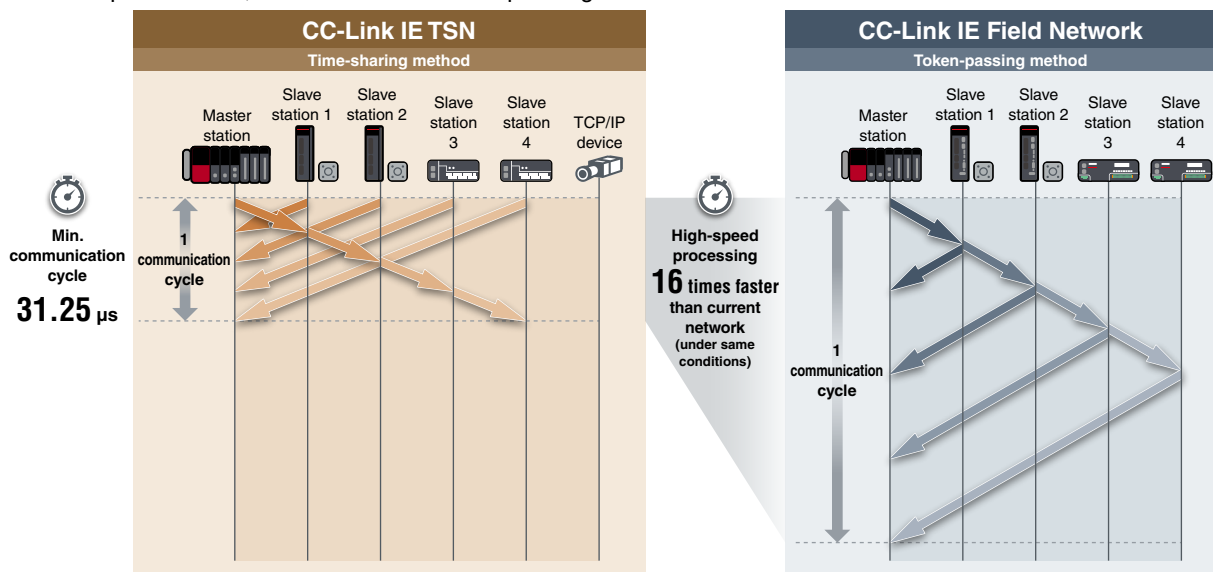

Deterministic control even when mixed with TCP/IP communication TSN Technology

Deterministic performance of cyclic communication is maintained even when mixed with slower information data (non real-time). This enables TCP/IP communication devices to be used without affecting overall control.

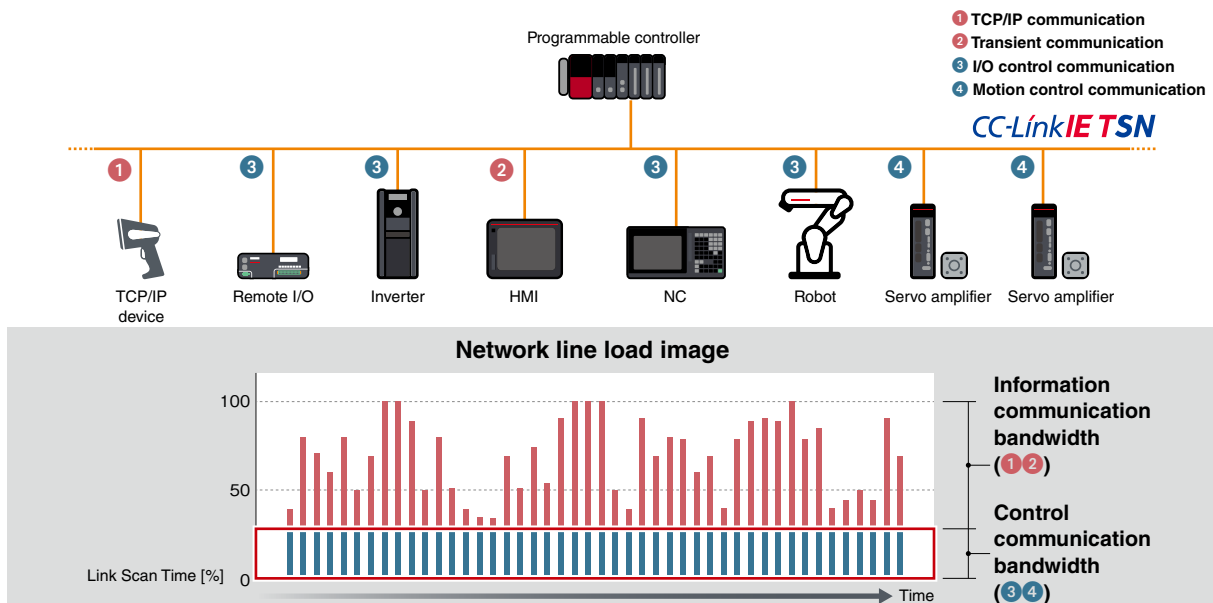

*1. Future release
 *2. Comparison with CC-Link IE Field Motion
 *3. Comparison with CC-Link IE Field Network

Optimum control when mixing devices with different communication cycles

Communication cycle 3 set points

TSN Technology

High-speed communication devices ideal for high-speed, highly accurate control and slower response devices ideal for monitoring can be connected using the same line by separating the communication cycle according to speed. This can maximize productivity by using optimum communication cycles based on device performance, such as remote stations that require high-speed control and status monitoring stations that operate at lower communication speeds.

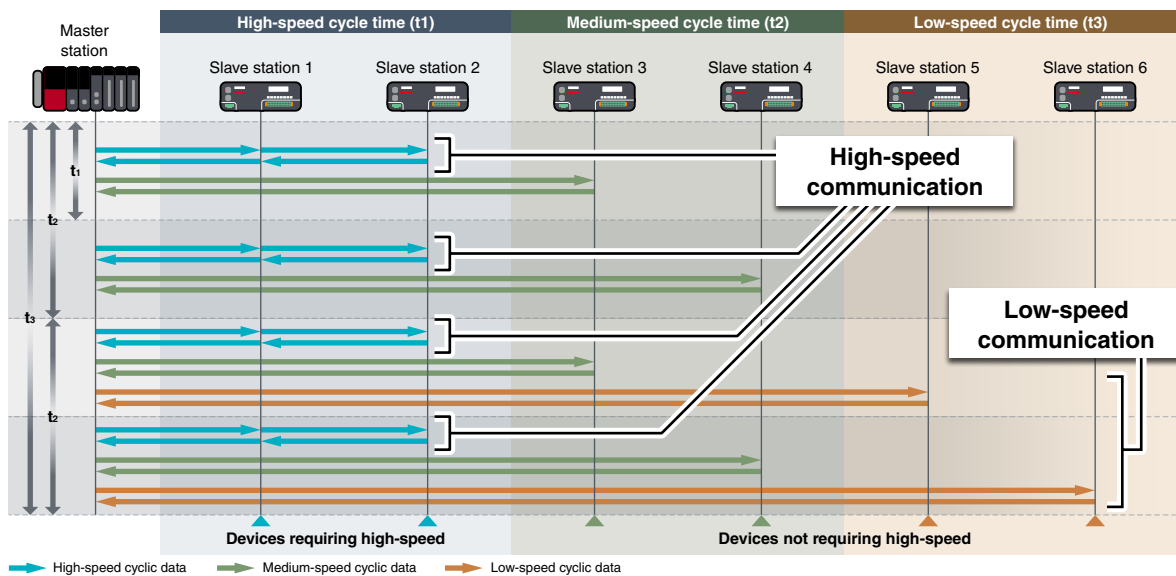

Realize high-accuracy synchronous control

Synchronization accuracy $\pm 1 \mu\text{s}$

Max. number of synchronized axes: 256 axes

TSN Technology

Servo amplifier and other slave stations can be connected on the same network, enabling synchronous motion control between servo motors and slave stations.

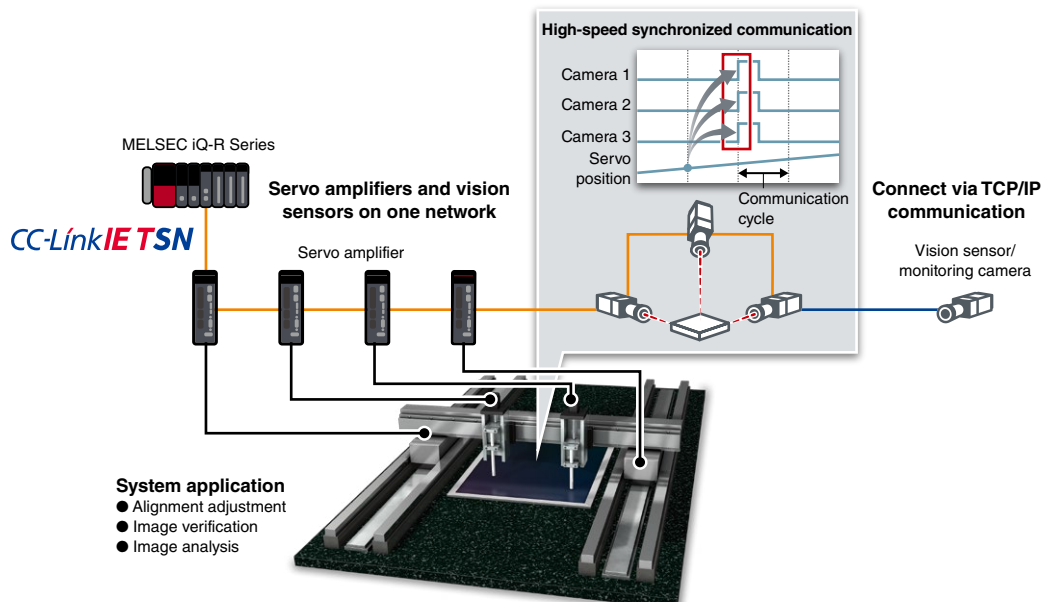

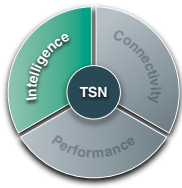

Intelligence

Auto-generation of network parameters Easy startup

Automatic generation of system parameters is relatively easy; simply connect the engineering software with the network master station. New parameters are reflected automatically even when the system configuration changes, reducing overall network setup time.

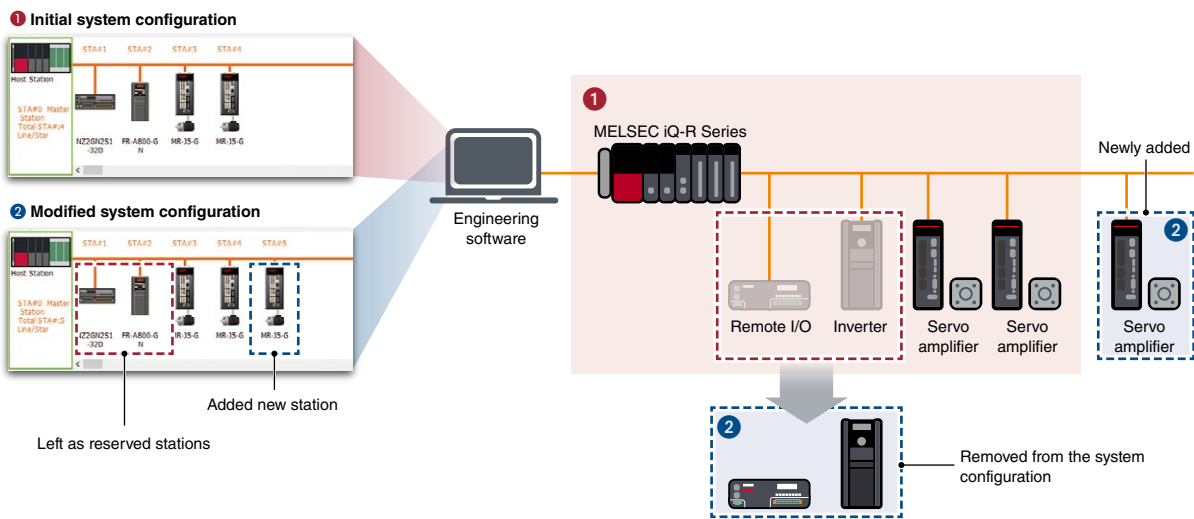

Easier troubleshooting using third-party Ethernet diagnostic tools supporting SNMP Easy diagnostics

General Ethernet diagnostics software compatible with SNMP*1 can be used for monitoring CC-Link IE TSN and Ethernet network devices. In addition to providing detailed diagnostics of devices supported by CC-Link IE TSN, system-wide diagnostic analysis and monitoring across the entire network are possible.

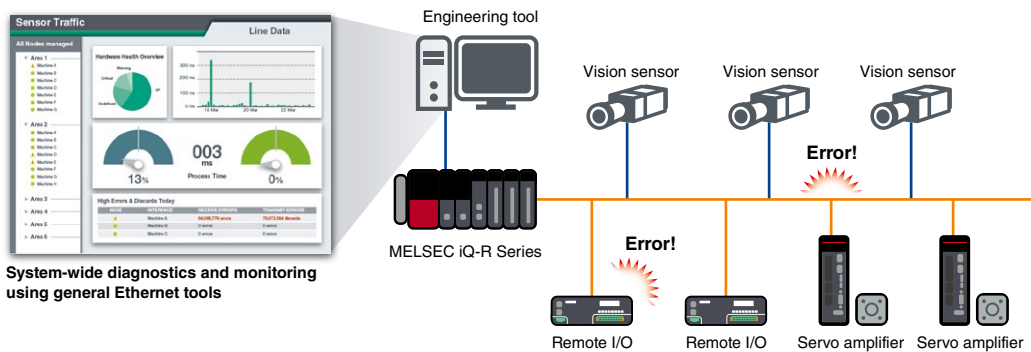

*1. SNMP: Simple network management protocol

Error cause analysis with highly precise time synchronization

SoE

TSN Technology

Highly accurate time synchronization accuracy within $\pm 1\mu\text{s}$ and each station connected to the network sharing time stamp information in 1 ms units improves system diagnostics and troubleshooting by enabling sequential analysis of stations in the network. The error history is displayed consecutively based on time stamp data, enabling accurate analysis of the cause of error using the actual time the event occurred.

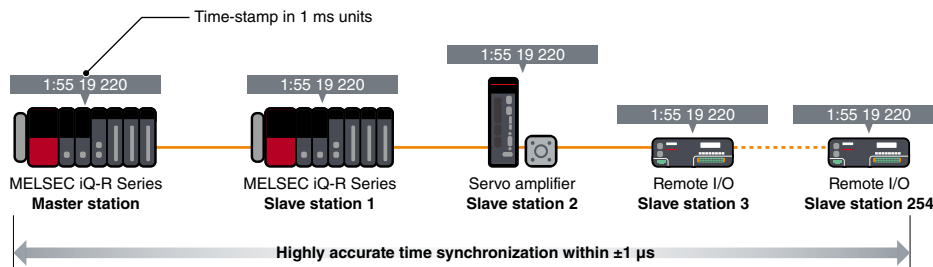

Prevent unauthorized access using IP filter and remote password

IP filter is used to identify IP addresses of devices to prevent access to the CPU module from unauthorized IP addresses by setting the parameters to either allow or block transmission preventing access from unauthorized devices. Remote passwords can be set from the parameters, allowing external devices access after authentication.

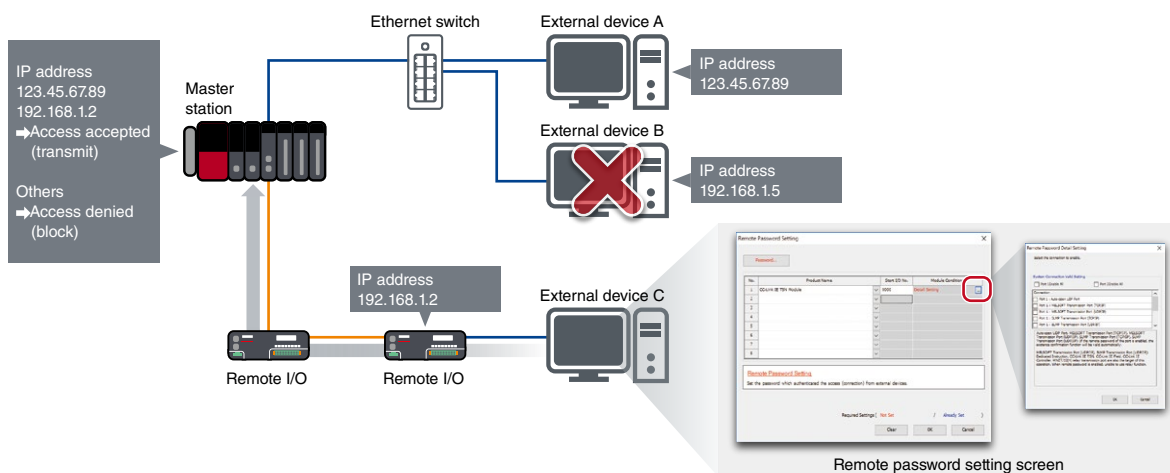



Connectivity

Combining real-time control and TCP/IP communication

Standard Ethernet Utilize TSN technology Mixed communications

TSN Technology

Supporting standard Ethernet enables various network-compatible devices and diagnostic software to be used, realizing an integrated network infrastructure that is easy to maintain. Ethernet communications supporting TCP/IP communication such as information that has been collected and analyzed by edge devices and IT systems can be mixed in the same line with the real-time control communications of CC-Link IE TSN.

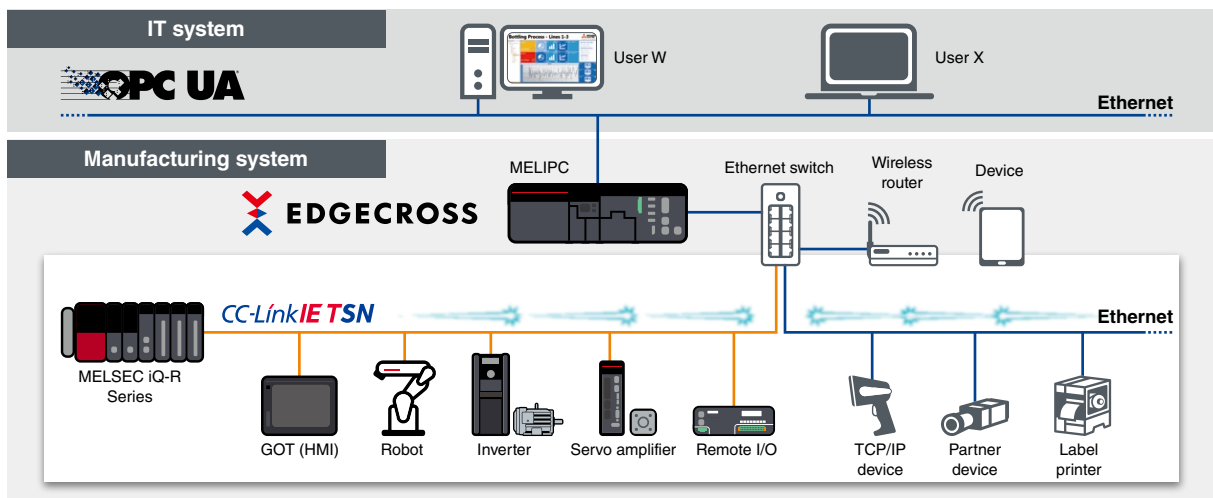

Easy replacement of slave devices Shorter startup

Network station parameters that are stored in the CPU module are automatically distributed to slave modules when initializing the network and when returning disconnected stations to the network. Individual registration of the parameters to each station is unnecessary after replacing slave devices.

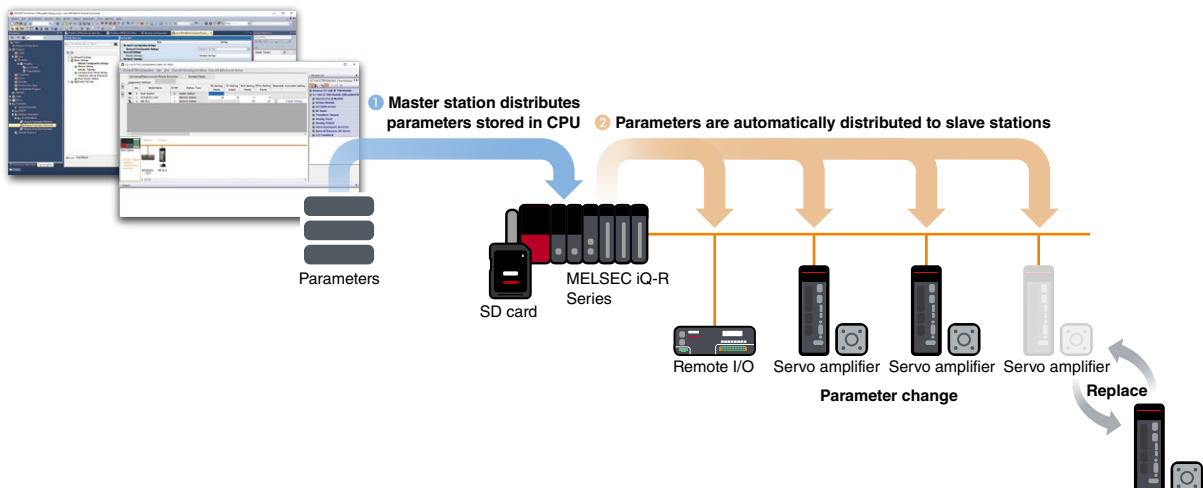

Flexible system configuration with multiple topologies Flexible system

Both line and star topologies are supported, ensuring the ideal system configuration for production requirements is achieved. Use line topology for high-speed, high-performance control, or choose a star topology if a more flexible system configuration is needed. Depending on Ethernet switch specifications, slave devices can be easily distributed to achieve the desired system configuration.

Line topology (twisted-pair cable)

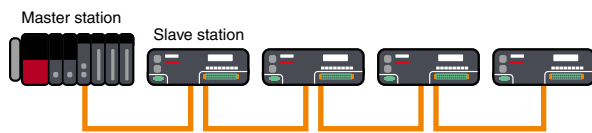

Star topology (twisted-pair cable)

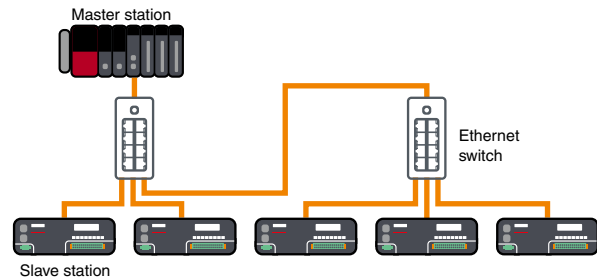

Ring topology Future release

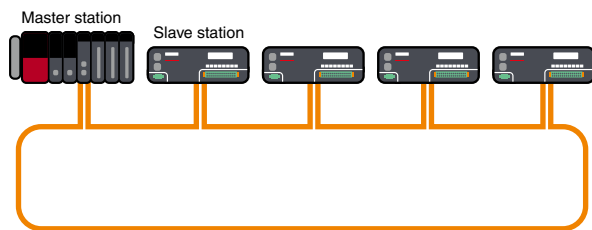

Highly scalable system utilizing best-in-class devices Various devices

Supports implementation of high-performance devices realized with a dedicated ASIC/FPGA, and low-cost devices using a software protocol stack on a standard Ethernet chip.



Item	Configuration 1	Configuration 2	Configuration 3	Configuration 4
System configuration	Hardware ^{*1} master Hardware slave	Software ^{*2} master Hardware slave	Hardware master Software slave	Software master Software slave
Transmission speed				
1 Gbps	●	●	●	●
100 Mbps	●	●	●	●

*1. Hardware master/slave: Development with dedicated LSI (ASIC, FPGA)

*2. Software master/slave: Development with software protocol stack (standard Ethernet chip)

System configuration

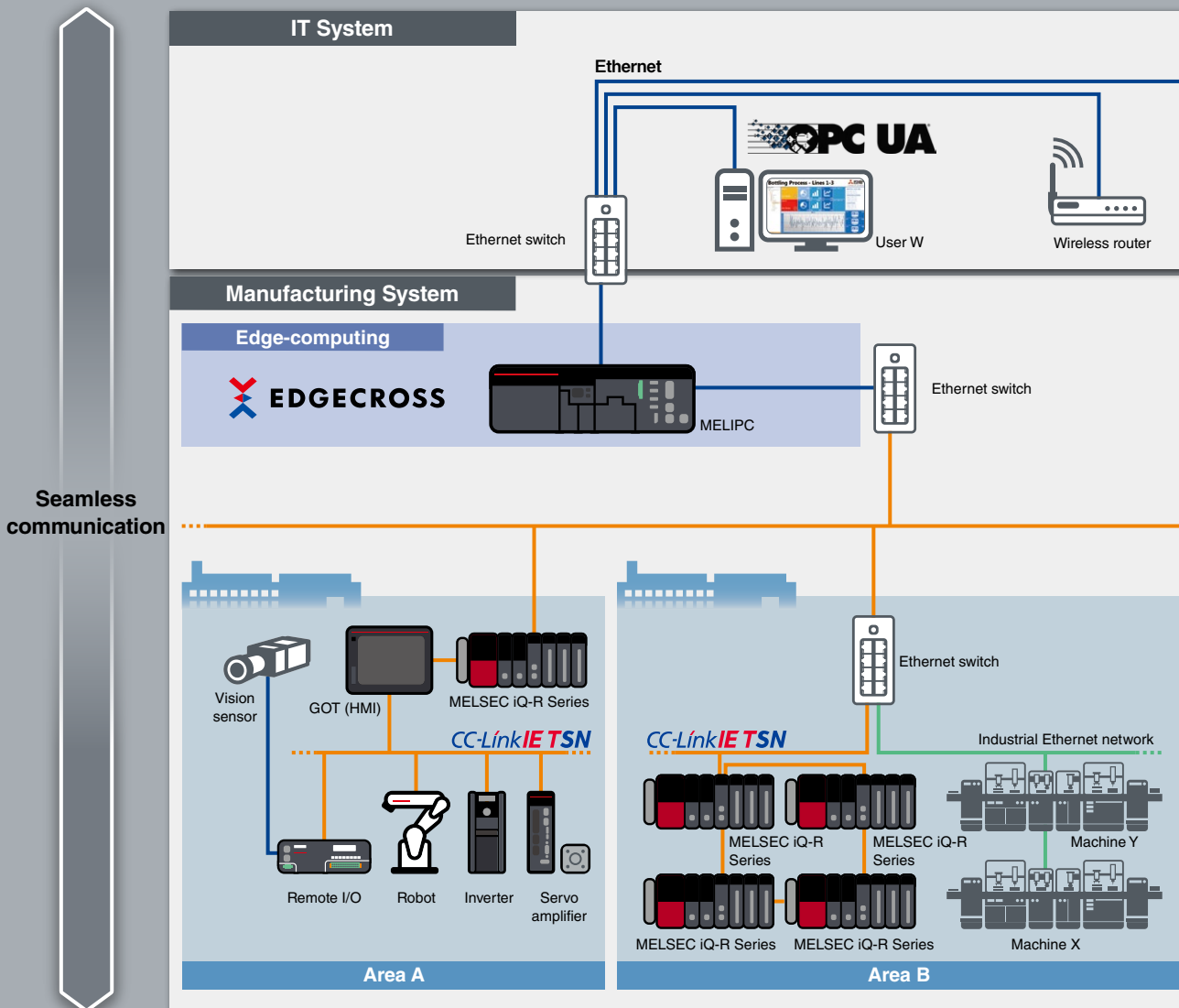

Flexible IIoT system configuration

CC-Link IE TSN utilizes TSN technology together with its support of TCP/IP communications enables mixing of information communication (non real-time) with Ethernet communication devices. This allows TCP/IP communication devices to be used without affecting real-time deterministic communications, thereby giving greater flexibility when connecting machines and equipment.

Increased productivity

Improved communication performance enables shorter production cycle time. Compared to current systems, adding further control axes and remote I/Os is much easier. In addition, optimum communication cycle times can be realized by supporting both high-speed and low-speed cycle communications according to device specifications.

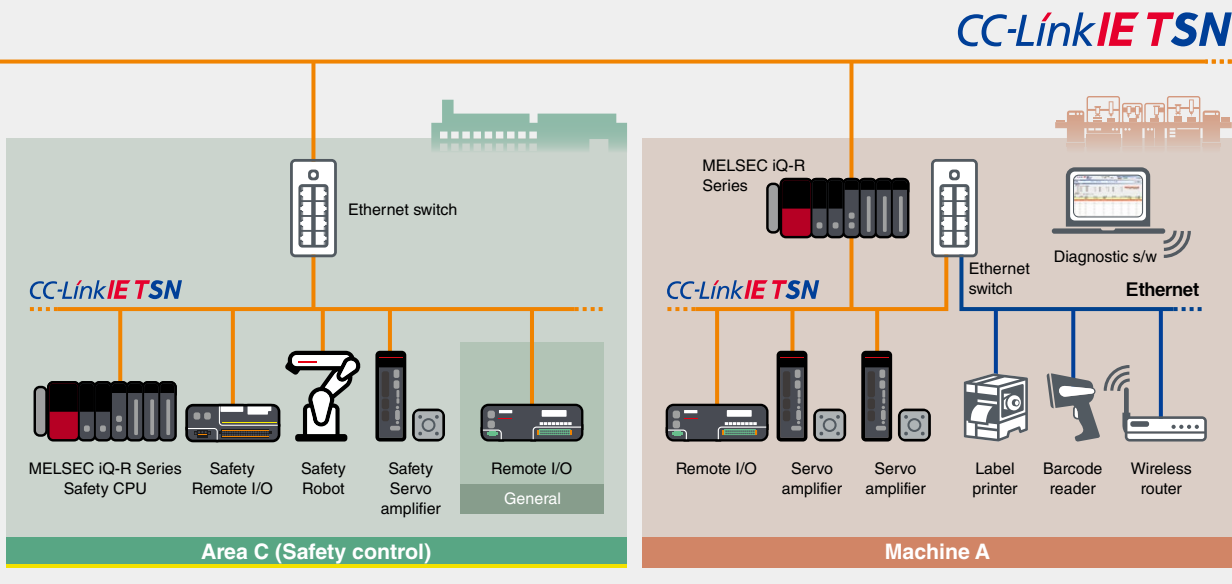
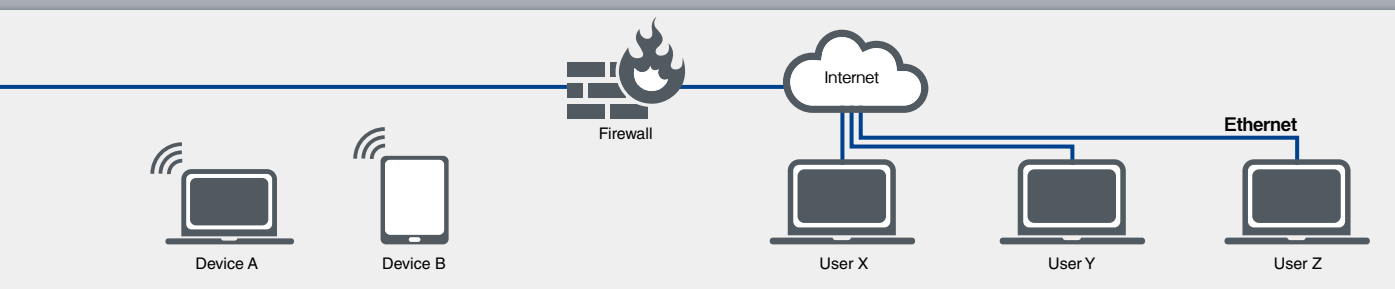

Reduce startup, engineering and maintenance costs

Through its support of SNMP, general Ethernet diagnostics software can be used to identify the network-related errors of CC-Link IE TSN and Ethernet devices more easily. The internal clocks of devices can be synchronized to within the microsecond, making it possible to log historical events in sequence and easily identify the cause of an error.

Various development methods available supporting different products

Product development for CC-Link IE TSN partner product vendors is relatively simple since various different options are available. These include a dedicated ASIC/FPGA option for devices that require high performance, and a software protocol stack suitable for lower cost devices that can utilize a general Ethernet chip for network implementation.

Master station



- Enables mixing of control and TCP/IP communications
- Automatically detects devices on the network, enabling easy network configuration
- Support various types of motion control
- Highly scalable motion control modules based on the application
- Motion control software embedded in IPCs realize CC-Link IE TSN-compatible motion control systems
- Select IPCs based on application requirements contributes to high system flexibility

MELSEC iQ-R Series master/local modules can be used as CC-Link IE TSN master/local stations. By supporting the simultaneous use of real-time motion control communication and TCP/IP communication, CC-Link IE TSN performance and functionality are maximized. MELSEC iQ-R Series motion modules also allow the use of multiple control functions, such as synchronization, cam, speed, and torque control using PLCopen® Motion Control function blocks. The ability to embed motion control software in industrial computers (IPCs) has enabled the realization of CC-Link IE TSN-compatible motion control systems.

MELSEC iQ-R Series master/local module

RJ71GN11-T2

Network management module maximizes CC-Link IE TSN performance and functionality

- Can be used as a CC-Link IE TSN master or local station
- Enables mixing of real-time control communication and TCP/IP communication
- Automatic detection of network devices and parameter distribution realizes easy network configuration



MELSEC iQ-R Series motion modules

RD78G RD78GH Future release

PLCopen® Motion Control function blocks realizes various controls

- PLCopen® Motion Control function blocks can easily perform various motion control functions such as, positioning, synchronization, cam, speed, and torque control
- RD78G64 supports a maximum of 64 axes and RD78GHW supports up to 256 axes*1
- Advanced motion control system realized by mixing servo amplifiers and I/O modules on one network
- GX Works3 programming software enables a one-stop solution for system design, debugging, and maintenance



*1. Future release

Motion software

SWM78*2 Future release

IPC-based motion control supports C/C++ programming language

- IPC-embedded motion control software realizes a CC-Link IE TSN-compatible motion control system
- Multiple motion control functions, such as positioning, synchronization, cam, speed, and torque control
- Utilizes an API library having the same interface as PLCopen® Motion Control function blocks
- Control up to 256 axes*3

*2. Included in the motion control software development kit MELSOFT EM78 SDK.
 *3. Future release



Features

System configuration

Master station

Slave station
Drives/GOT (HMI)

Slave station
Block-type remote modules

Development tools

Slave station Drives/GOT (HMI)



- Quick tuning function for servo amplifiers controls vibration and suppresses overshoot within 0.3 s
- Machine diagnosis of mechanical parts (ball screws, linear guides, belts, and gears) improves predictive maintenance
- High-speed communication together with high-performance inverter improves productivity
- Remote system-wide monitoring enabled using GOT Mobile function
- Various sample screens available, enabling the visualization of network device statuses from the GOT (HMI)

Drive products such as servo amplifiers and inverters, together with GOTs (HMIs) all support CC-Link IE TSN. The MELSERVO-J5 Series servo amplifiers, when combined with motion modules, realize highly accurate motion control that contributes to the performance of smart factory production systems. The Inverter A800 Series is equipped with CC-Link IE TSN, enabling real-time collection of production data, and the GOT2000 Series HMI, which enhances coordination with automation devices, thereby improving productivity and efficiency.

AC servo MELSERVO-J5 Series

MR-J5-G MR-J5W2-G MR-J5W3-G

Next generation MELSERVO-J5 Series improves production systems

- Highly accurate synchronous control when combined with a motion module or software-based motion controller
- Equipped with a quick tuning function, suppressing vibration and overshoot within 0.3 s
- Absolute positioning system without requiring a battery when used with HK series servo motors
- Machine diagnosis of ball screws, linear guides, belts, and gears improves predictive maintenance



Inverter A800 Series

FR-A800-GN

Industry-leading high performance and quality

- Built-in CC-Link IE TSN communications
- Shop floor data collection in real-time using high-speed gigabit communication and efficient network protocol
- Multiple open Ethernet networks can be mixed on one cable, supporting the combination of various applications



HMI GOT2000 Series communication unit

GT25-J71GN13-T2

Improves productivity and efficiency through advanced visualization of production equipment

- CC-Link IE TSN-compatible GOT (HMI) communication unit
- Use as a CC-Link IE TSN local station
- Supported GOT2000 Series models: GT27, GT25*¹

*1. GT2505, GT2510-W, GT2507-W, GT2507T, GT2506HS, and GT2505HS are not supported.



Features

System configuration

Master station

Slave station
Drives/GOT (HMI)

Slave station
Block-type remote modules

Development tools

Slave station Block-type remote modules



- Easily set parameters using only hardware switches
- Detection of low power supply voltage
- Spring-clamp terminal block reduces wiring
- Input module conforms to IEC61131-2 Type3 (digital input standard operation range), supporting various sensors

Block type remote modules are recognized as slave stations on the CC-Link IE TSN Network. They are mainly used when installation requires them to be close to connected I/Os to save on wiring. Digital I/O modules are the sensors of the automation system and can be easily connected to switches, indicator lamps, sensors, and other devices. Analog modules can be connected to devices that process varying voltages and current signals.

■ Easier system startup

The IP address for each module can be set easily using the switches on the front of the module. Additional functions can be set using switches as well, without requiring dedicated engineering software.

■ Detect low power supply voltage

Future support

Remote I/O modules detect low voltage conditions and notifies the master station. This simplifies troubleshooting when the power supplied to the module is fluctuating or if there is a wiring contact failure.

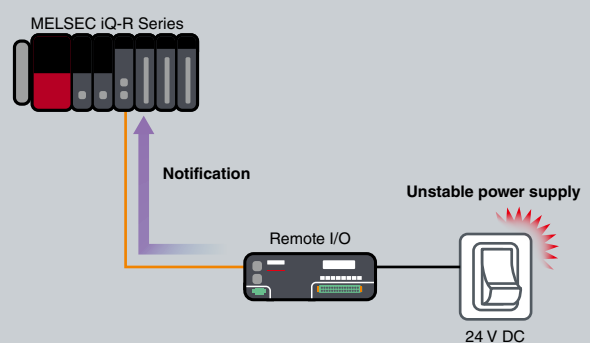
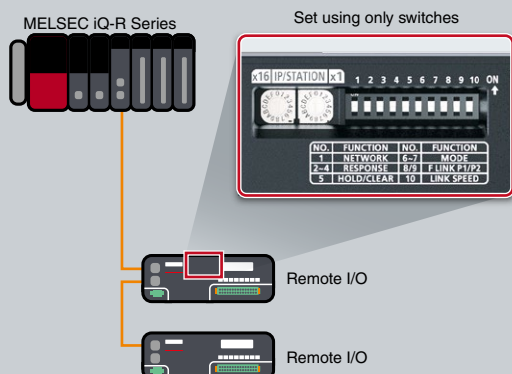

Input modules

- Response time can be set at 0 ms, 0.2 ms, 1 ms, 1.5 ms, 5 ms, 10 ms, 20 ms and 70 ms (initial setting is 1 ms)
- Input ON/OFF voltage and current comply with IEC61131-2 (digital input standard operating range) Type3, supporting various sensors
- Functions can be easily setup from the front of the module using switches, without requiring dedicated engineering software

Spring-clamp terminal block NZ2GN2S1-32D



Model	Input type (DC input)	Input points	Rated input voltage/current	Wiring type
NZ2GN2S1-32D	Positive common Negative common	32 points	24 V DC (6 mA)	1-wire

Screw terminal block NZ2GN2B1-32D



Model	Input type (DC input)	Input points	Rated input voltage/current	Wiring type
NZ2GN2B1-32D	Positive common Negative common	32 points	24 V DC (6 mA)	1-wire

Output modules

- Select either to hold or clear the output value when disconnected from the data link or when the master stations programmable controller CPU has stopped
- Prevents module malfunction using the output overload and overheat protection function
- Functions can be easily setup from the front of the module using switches, without requiring dedicated engineering software

Spring-clamp terminal block NZ2GN2S1-32T NZ2GN2S1-32TE



Model	Output type (Transistor output)	Output points	Rated load voltage/ Max. load current	Wiring type
NZ2GN2S1-32T	Sink	32 points	12/24 V DC (0.5 A)	1-wire
NZ2GN2S1-32TE	Source	32 points	12/24 V DC (0.5 A)	1-wire

Screw terminal block NZ2GN2B1-32T NZ2GN2B1-32TE



Model	Output type (Transistor output)	Output points	Rated load voltage/ Max. load current	Wiring type
NZ2GN2B1-32T	Sink	32 points	12/24 V DC (0.5 A)	1-wire
NZ2GN2B1-32TE	Source	32 points	12/24 V DC (0.5 A)	1-wire

I/O combined modules

- Combined I/O modules include both input module and output module functions
- Response time can be set at 0 ms, 0.2 ms, 1 ms, 1.5 ms, 5 ms, 10 ms, 20 ms, and 70 ms (initial setting is 1 ms)
- Input ON/OFF voltage and current comply with IEC61131-2 (digital input standard operating range) Type3, supporting various sensors
- Select either to hold or clear the output value when disconnected from the data link or when the master station's programmable controller CPU has stopped
- Prevents module malfunction using the output overload and overheat protection function
- Functions can be easily setup from the front of the module using switches, without requiring dedicated engineering software

Spring-clamp terminal block

NZ2GN2S1-32DT
NZ2GN2S1-32DTE



Model	Input type DC input	Input points	Rated input voltage/ current	Output type Transistor output	Output points	Rated load voltage/ Max. load current	Wiring type
NZ2GN2S1-32DT	Positive common	16 points	24 V DC (6 mA)	Sink	16 points	24 V DC (0.5 A)	1-wire
NZ2GN2S1-32DTE	Negative common	16 points	24 V DC (6 mA)	Source	16 points	24 V DC (0.5 A)	1-wire

Screw terminal block

NZ2GN2B1-32DT
NZ2GN2B1-32DTE



Model	Input type DC input	Input points	Rated input voltage/ current	Output type Transistor output	Output points	Rated load voltage/ Max. load current	Wiring type
NZ2GN2B1-32DT	Positive common	16 points	24 V DC (6 mA)	Sink	16 points	24 V DC (0.5 A)	1-wire
NZ2GN2B1-32DTE	Negative common	16 points	24 V DC (6 mA)	Source	16 points	24 V DC (0.5 A)	1-wire

Analog input modules

- 200 μ s/channel analog input module conversion speed
- Functions can be easily setup from the front of the module using switches, without requiring dedicated engineering software

Spring-clamp terminal block

NZ2GN2S-60AD4



Model	Input type	Number of channels
NZ2GN2S-60AD4	Analog voltage/current input	4

Screw terminal block

NZ2GN2B-60AD4



Model	Input type	Number of channels
NZ2GN2B-60AD4	Analog voltage/current input	4

■ Analog output modules

- 200 μ s/channel analog output module conversion speed
- Functions can be easily setup from the front of the module using switches, without requiring dedicated engineering software

Spring-clamp terminal block NZ2GN2S-60DA4



Model	Output type	Number of channels
NZ2GN2S-60DA4	Analog voltage/current output	4

Screw terminal block NZ2GN2B-60DA4



Model	Output type	Number of channels
NZ2GN2B-60DA4	Analog voltage/current output	4

Master station software development kit (SDK) Future support

- Various systems can be configured using the software protocol stack for both high-performance or inexpensive computers
- API compliance with CANopen® makes it easy for developers of CANopen®-compatible products to develop CC-Link IE TSN-compatible products
- Source code package can be customized, enabling function expansion and porting to different development environments
- Kit with library allows system configuration at a lower cost
- Embedded functions improves devices by utilizing features such as mixing TCP/IP communication and multiple cycle times

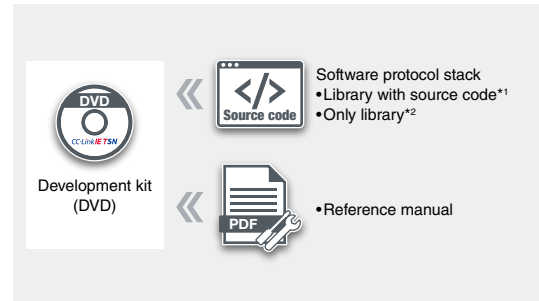

*1. SW1DTD-GNSDK1M
*2. SW1DTD-GNSDK2M

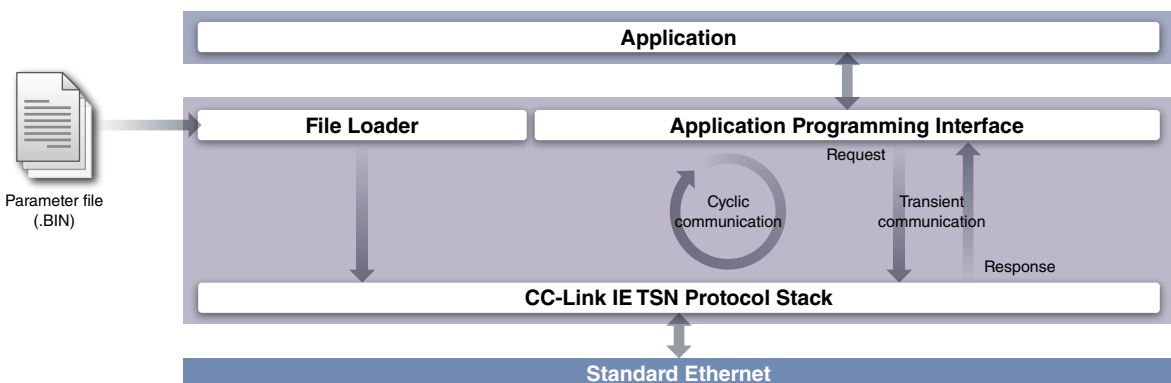

Remote station software development kit (SDK)

- Software protocol stack requires only a few resources for operation, enabling it to run on low-cost microcomputers
- Log function enables tracing of errors and process status in the protocol stack when debugging
- Provides all resources such as API and wrapper layer as the source code, simplifying porting to development environments
- API compatibility with the sample code of CC-Link IE Field Network Basic remote stations allows developers to easily transition CC-Link IE TSN-compatible products

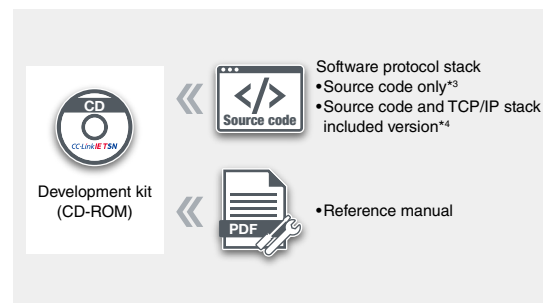

*3. SW1DNC-GNSDK1S-M
*4. SW1DNC-GNSDK2S-M

■ Communication LSI embedded with GbE-PHY CP620

- CC-Link IE TSN remote station can be developed without considering protocols
- Embedded GbE-PHY enables easier communication circuit pattern development with fewer peripheral parts and circuits required around the CPU and GbE-PHY, thereby reducing board size
- Customized sample codes according to hardware specifications and applications can be provided
- Embedded hardware RTOS*1 reduces CPU load and power consumption

*1. RTOS: Real-time operating system

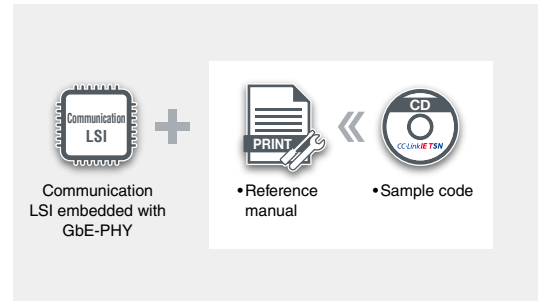

General specifications

The following table provides the environmental specifications required for using the master/local module and CC-Link IE TSN block-type modules listed in this catalog. For the environmental specifications required to use other products, please refer to the relevant product catalog or manual.

Item	Master/local module Block type remote module				
	Operating ambient temperature	0...55°C			
Storage ambient temperature	-25...75°C				
Operating ambient humidity	5...95% RH, non-condensing				
Storage ambient humidity	5...95% RH, non-condensing				
Vibration resistance	Compliant with JIS B 3502, IEC 61131-2				
	Under intermittent vibration	Frequency	Constant acceleration	Half amplitude	Sweep count
		5...8.4 Hz	-	3.5 mm	10 times each in X, Y, Z directions
	8.4...150 Hz	9.8 m/s ²	-		
	Under continuous vibration	5...8.4 Hz	-	1.75 mm	-
8.4...150 Hz		4.9 m/s ²	-		
Shock resistance	Compliant with JIS B 3502 and IEC 61131-2 (147 m/s ² , 3 times in each of 3 directions X, Y, Z)				
Operating atmosphere	No corrosive gases, no flammable gases, no excessive conductive dust				
Operating altitude*1	0...2000 m				
Installation location	Inside a control panel*2				
Overvoltage category*3	≤ 2				
Pollution level*4	≤ 2				
Equipment class	Class 1				

*1. Do not use or store the programmable controller under pressure higher than the atmospheric pressure of altitude 0 m. Doing so may cause malfunction.

*2. The module can be used in the environment outside the control panel where satisfying operating ambient temperature and humidity.

*3. This indicates the section of the power supply to which the equipment is assumed to be connected between the public electrical power distribution network and the machinery within premises.

Category II applies to equipment for which electrical power is supplied from fixed facilities.

The surge voltage withstand level for up to the rated voltage of 300 V is 2500 V.

*4. This index indicates the degree to which conductive material is generated in terms of the environment in which the equipment is used.

Performance specifications

Item	MELSEC iQ-R Series master/local module RJ71GN11-T2	MELSEC iQ-R Series motion module RD78G□
	Communication speed	1 Gbps
Maximum stations per network*5	121	65
Connection cable	Ethernet cable (Category 5e or higher)	
Overall cable distance	Line: 12000 m Ring: 12100 m Others: Depends on system configuration	Line: 6400 m
Maximum station-to-station distance (m)	100	
Maximum number of networks	239	
Network topology	Line, star, ring*6	Line, star
Communication method	Time-sharing method	
Maximum link points per network		
RX/RX	16384 points, 2K bytes	-
RW/RWw	8192 points, 16K bytes	-
LB	32768 points, 4K bytes	-
LW	16384 points, 32K bytes	-
Maximum link points per station		
RX/RX	16384 points, 2K bytes	-
RW/RWw	8192 points, 16K bytes	-
LB	32768 points, 4K bytes	-
LW	16384 points, 32K bytes	-
Transient transmission capacity		
Transient transmission capacity	1920 bytes maximum	

*5. Includes a master station.

*6. Ring type will be supported in the future.

Network topologies

Line topology (twisted-pair cable)

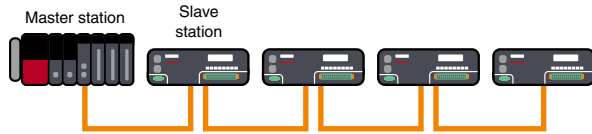

Network topology ideal for system configurations with high-speed/high-performance control

- High-speed communication is possible as the system is configured with CC-Link IE TSN-compatible slave devices only
- Easier system configuration without an Ethernet switch
- Ideal for highly accurate motion control systems

Star topology (twisted-pair cable)

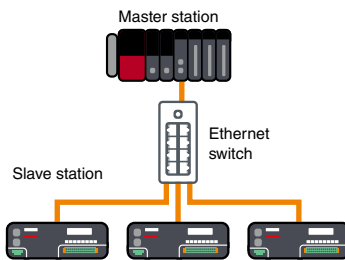

Network topology ideal for flexible system configurations

- Easily realizes distributed arrangement of slave devices depending on Ethernet switch specifications
- Easy to change/rearrange equipment or system configuration
- Ideal for general production line control systems

Certified class

CC-Link IE TSN certifies nodes and switches to a specific class level according to its functionality and performance classification. Products can be classified as either class A or B. For the certified classification of each product, please check the CC-Link partner association website or the relevant product catalog or manual. Supported functions and system configuration may differ according to the certified class of products used. For example, products compatible with certified class B are necessary to configure a high-speed motion control system. For details of configuring systems with both class A and class B devices, please refer to relevant master product manual.

System configuration

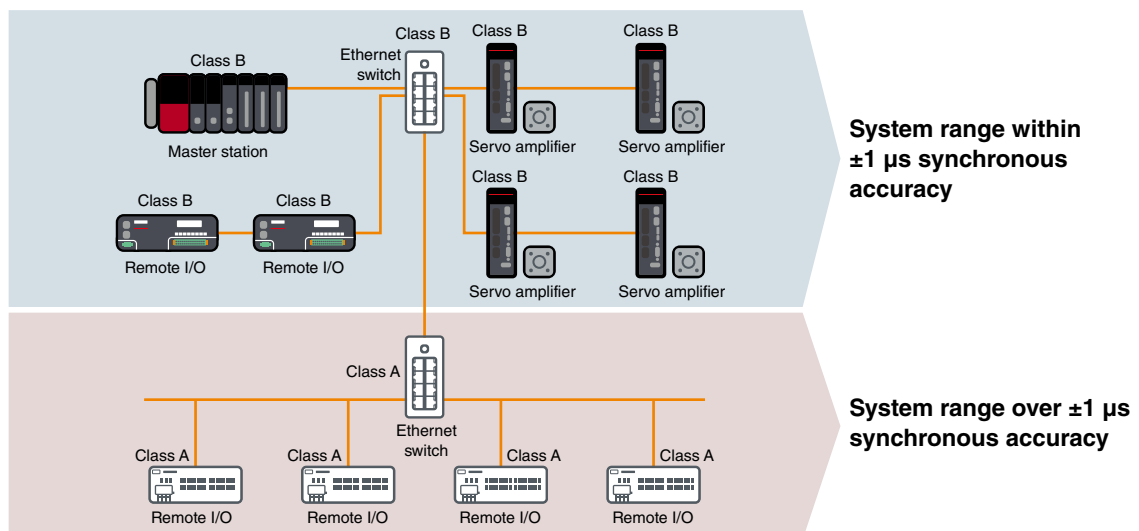

- Synchronous accuracy of a system varies relative to the combination of connected devices and switches certification class
- Use class B devices when configuring a system within $\pm 1 \mu\text{s}$ high-accuracy synchronization, connect class A devices to a separate branch line from class B devices (for details of system configuration, please refer to relevant master product manual)

Extensive global support coverage providing expert help whenever needed

■ Global FA centers

■ EMEA

Europe FA Center

MITSUBISHI ELECTRIC EUROPE B.V. Polish Branch
Tel: +48-12-347-65-81

Germany FA Center

MITSUBISHI ELECTRIC EUROPE B.V. German Branch
Tel: +49-2102-486-0 / Fax: +49-2102-486-1120

UK FA Center

MITSUBISHI ELECTRIC EUROPE B.V. UK Branch
Tel: +44-1707-27-8780 / Fax: +44-1707-27-8695

Czech Republic FA Center

MITSUBISHI ELECTRIC EUROPE B.V. Czech Branch
Tel: +420-255 719 200

Italy FA Center

MITSUBISHI ELECTRIC EUROPE B.V. Italian Branch
Tel: +39-039-60531 / Fax: +39-039-6053-312

Russia FA Center

MITSUBISHI ELECTRIC (RUSSIA) LLC ST.
Petersburg Branch
Tel: +7-812-633-3497 / Fax: +7-812-633-3499

Turkey FA Center

MITSUBISHI ELECTRIC TURKEY A.S Umraniye Branch
Tel: +90-216-526-3990 / Fax: +90-216-526-3995

■ Asia-Pacific

China

Beijing FA Center

MITSUBISHI ELECTRIC AUTOMATION (CHINA) LTD.
Beijing FA Center
Tel: +86-10-6518-8830 / Fax: +86-10-6518-2938

Guangzhou FA Center

MITSUBISHI ELECTRIC AUTOMATION (CHINA) LTD.
Guangzhou FA Center
Tel: +86-20-8923-6730 / Fax: +86-20-8923-6715

Shanghai FA Center

MITSUBISHI ELECTRIC AUTOMATION (CHINA) LTD.
Shanghai FA Center
Tel: +86-21-2322-3030 / Fax: +86-21-2322-3000

Tianjin FA Center

MITSUBISHI ELECTRIC AUTOMATION (CHINA) LTD.
Tianjin FA Center
Tel: +86-22-2813-1015 / Fax: +86-22-2813-1017

Taiwan

Taipei FA Center

SETSUYO ENTERPRISE CO., LTD.
Tel: +886-2-2299-9917 / Fax: +886-2-2299-9963

Korea

Korea FA Center

MITSUBISHI ELECTRIC AUTOMATION KOREA CO., LTD.
Tel: +82-2-3660-9632 / Fax: +82-2-3664-0475

Thailand

Thailand FA Center

MITSUBISHI ELECTRIC FACTORY AUTOMATION
(THAILAND) CO., LTD.
Tel: +66-2682-6522-31 / Fax: +66-2682-6020

ASEAN

ASEAN FA Center

MITSUBISHI ELECTRIC ASIA PTE. LTD.
Tel: +65-6470-2480 / Fax: +65-6476-7439

Indonesia

Indonesia FA Center

PT. MITSUBISHI ELECTRIC INDONESIA
Cikarang Office
Tel: +62-21-2961-7797 / Fax: +62-21-2961-7794

Vietnam

Hanoi FA Center

MITSUBISHI ELECTRIC VIETNAM COMPANY LIMITED
Hanoi Branch Office
Tel: +84-4-3937-8075 / Fax: +84-4-3937-8076

Ho Chi Minh FA Center

MITSUBISHI ELECTRIC VIETNAM COMPANY LIMITED
Tel: +84-8-3910-5945 / Fax: +84-8-3910-5947

India

India Ahmedabad FA Center

MITSUBISHI ELECTRIC INDIA PVT. LTD.
Ahmedabad Branch
Tel: +91-7965120063

India Bangalore FA Center

MITSUBISHI ELECTRIC INDIA PVT. LTD.
Bangalore Branch
Tel: +91-80-4020-1600 / Fax: +91-80-4020-1699

India Chennai FA Center

MITSUBISHI ELECTRIC INDIA PVT. LTD.
Chennai Branch
Tel: +91-4445548772 / Fax: +91-4445548773

India Gurgaon FA Center

MITSUBISHI ELECTRIC INDIA PVT. LTD.
Gurgaon Head Office
Tel: +91-124-463-0300 / Fax: +91-124-463-0399

India Pune FA Center

MITSUBISHI ELECTRIC INDIA PVT. LTD.
Pune Branch
Tel: +91-20-2710-2000 / Fax: +91-20-2710-2100

■ Americas

USA

North America FA Center

MITSUBISHI ELECTRIC AUTOMATION, INC.
Tel: +1-847-478-2469 / Fax: +1-847-478-2253

Mexico

Mexico City FA Center

MITSUBISHI ELECTRIC AUTOMATION, INC.
Mexico Branch
Tel: +52-55-3067-7511

Mexico FA Center

MITSUBISHI ELECTRIC AUTOMATION, INC.
Queretaro Office
Tel: +52-442-153-6014

Mexico Monterrey FA Center

MITSUBISHI ELECTRIC AUTOMATION, INC.
Monterrey Office
Tel: +52-55-3067-7521

Brazil

Brazil FA Center

MITSUBISHI ELECTRIC DO BRASIL COMERCIO E
SERVICOS LTDA.
Tel: +55-11-4689-3000 / Fax: +55-11-4689-3016

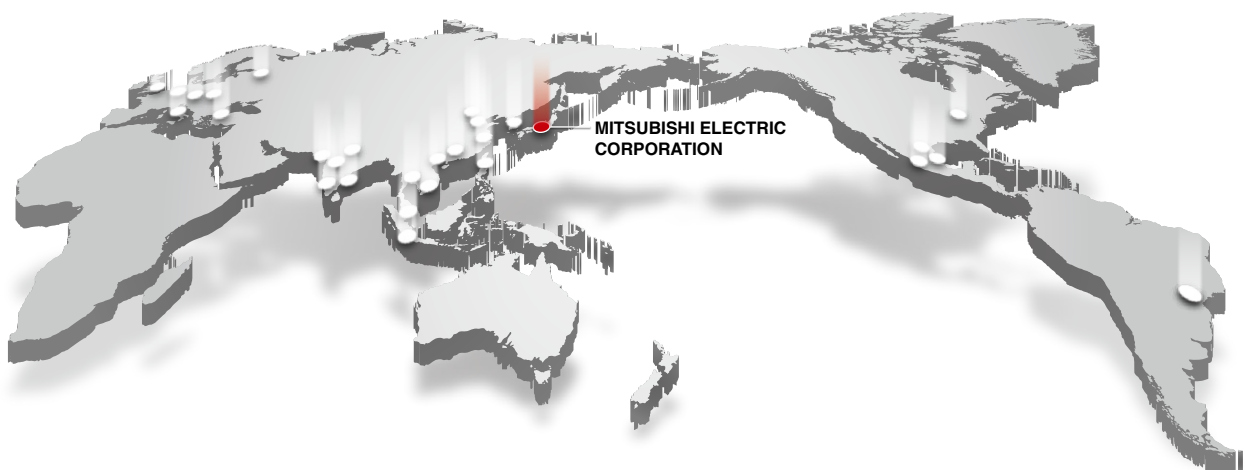

CC-Link Partner Association (CLPA) - Actively promoting worldwide adoption of CC-Link networks

Proactively supporting CC-Link, from promotion to specification development

The CC-Link Partner Association (CLPA) was established to promote the worldwide adoption of the CC-Link open-field network. By conducting promotional activities such as organizing trade shows and seminars, conducting conformance tests, and providing catalogs, brochures and website information, CLPA activities are successfully increasing the number of CC-Link partner manufacturers and CC-Link-compatible products. As such, CLPA is playing a major role in the globalization of CC-Link.



Seminar

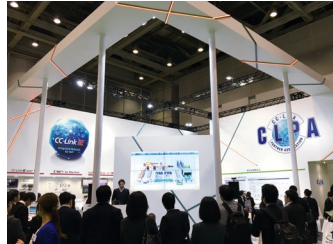

Trade show



Conformance testing lab

Visit the **CLPA website for the latest CC-Link information.**

URL: www.cc-link.org



CLPA Headquarters
 6F Ozone Front Bldg. 3-15-58 Ozone
 Kita-ku, Nagoya 462-0825, JAPAN
 TEL: +81-52-919-1588 FAX: +81-52-916-8655
 e-mail: info@cc-link.org



Global influence of CC-Link continues to spread

CC-Link is supported globally by CLPA. With offices throughout the world, support for partner companies can be found locally. Each regional CLPA office undertakes various support and promotional activities to further the influence of CC-Link/CC-Link IE in that part of the world. For companies looking to increase their presence in their local area, CLPA is well placed to assist these efforts through offices in all major regions.

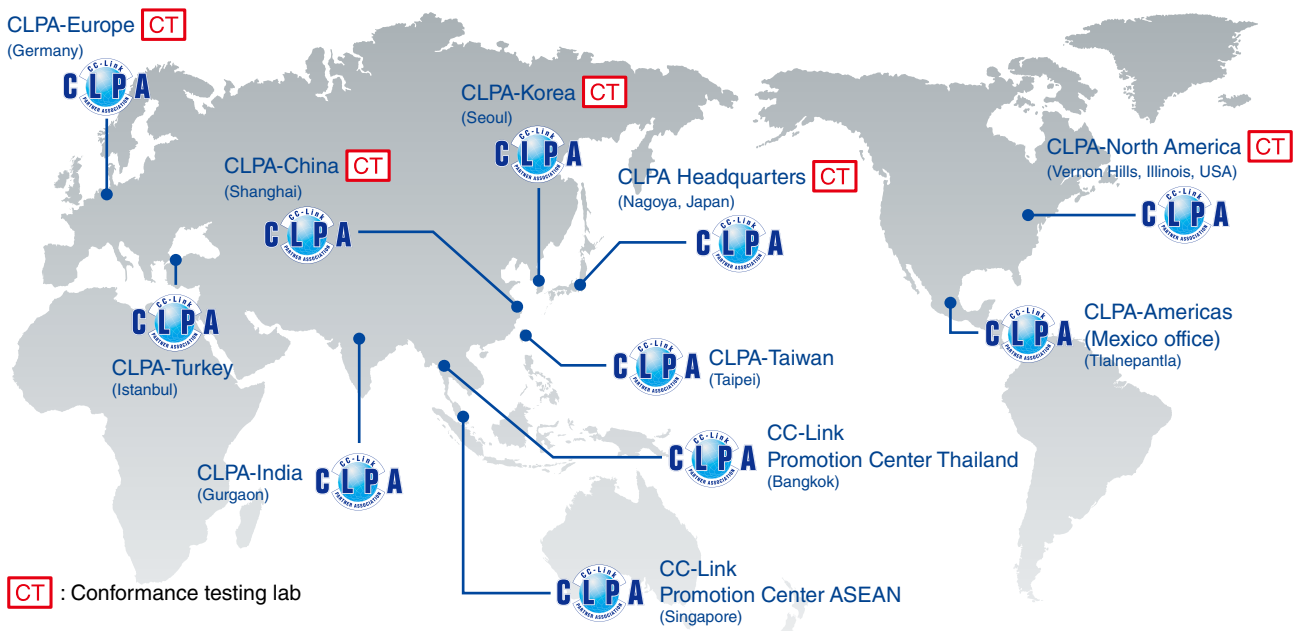

Factory Automation Global website

Mitsubishi Electric Factory Automation provides a mix of services to support its customers worldwide. A consolidated global website is the main portal, offering a selection of support tools and a window to its local Mitsubishi Electric sales and support network.

■ From here you can find:

- Overview of available factory automation products
- Library of downloadable literature
- Support tools such as online e-learning courses, terminology dictionary, etc.
- Global sales and service network portal
- Latest news related to Mitsubishi Electric factory automation

**Mitsubishi Electric Factory Automation
Global website:
www.MitsubishiElectric.com/fa**

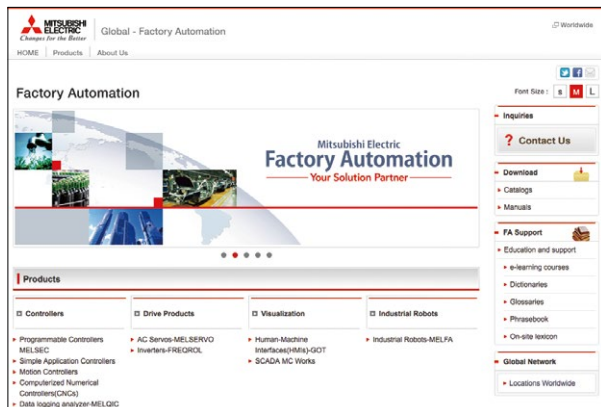

Online e-learning

An extensive library of e-learning courses covering the factory automation product range has been prepared. Courses from beginner to advanced levels of difficulty are available in various languages.

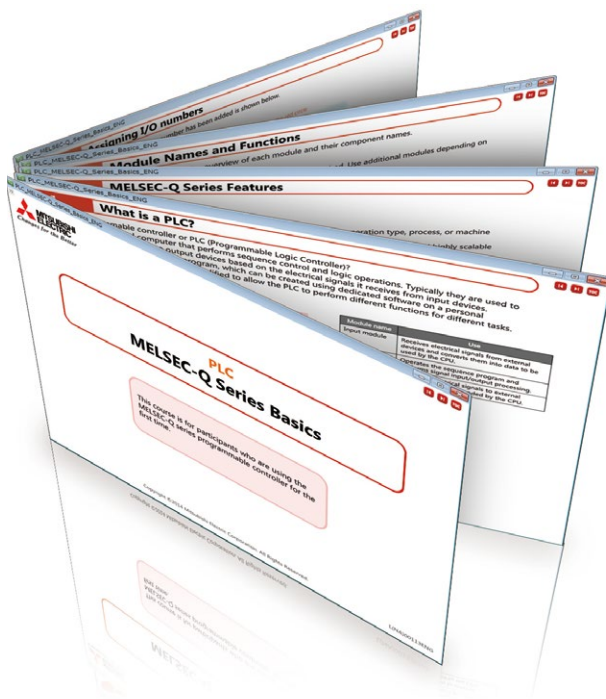

■ Beginner level

Designed for newcomers to Mitsubishi Electric Factory Automation products gaining a background of the fundamentals and an overview of various products related to the course.

■ Basic to Advanced levels

These courses are designed to provide education at all levels. Various different features are explained with application examples providing an easy and informative resource for in-house company training.

Innovative next-generation, e-Manual

The e-Manual viewer is a next-generation digital manual offered by Mitsubishi Electric that consolidates all manuals into an easy-to-use package with various useful features integrated into the viewer. The e-Manual is modeled around a centralized database allowing multiple manuals to be cross-searched at once, further reducing the time for reading individual product manuals when setting up a control system.



Key features include

- One-stop database containing all required manuals, with local file cache
- Included with GX Works3 engineering software
- Also available in tablet version
- Easily download manuals all at once
- Automatic update of manual versions
- Search information across multiple manuals
- Visual navigation from hardware diagram showing various specifications
- Customizable by adding user notes and bookmarks
- Directly port sample programs within manuals to GX Works3

MITSUBISHI ELECTRIC FA e-Manual (tablet version)



The e-Manual application is available on iOS and Android™ tablets. e-Manual files are provided as in-app downloads.



iOS
Version 8.1 or later

Download on the
App Store





Android™
Version 4.3/4.4/5.0

GET IT ON
Google Play



Supported versions

OS	OS version	Model
iOS	iOS 8.1 or later	Apple iPad 2, iPad (3rd generation), iPad (4th generation), iPad Air, iPad Air 2, iPad mini, iPad mini 2, iPad mini 3, iPad mini 4, iPad Pro (12.9 inch), iPad Pro (9.7 inch)
Android™	Android™ 4.3/4.4/5.0	ASUS Nexus7™ (2013)*1

*1. When using a tablet not listed above, 7-inch (resolution of 1920 x 1200 dots (WUXGA)) or better is recommended.

Product list

Type	Model name	Outline	Station type			Certified class
			Master station	Local station	Slave station Remote station	
MELSEC iQ-R Series master/local module						
	RJ71GN11-T2	Maximum number of connected stations: 121	●	●	-	B
MELSEC iQ-R Series motion modules						
	RD78G4	Maximum number of control axes: 4	●	-	-	B
	RD78G8	Maximum number of control axes: 8	●	-	-	
	RD78G16	Maximum number of control axes: 16	●	-	-	
	RD78G32	Maximum number of control axes: 32	●	-	-	
	RD78G64	Maximum number of control axes: 64	●	-	-	
	RD78GHV <small>Future release</small>	High-performance type, maximum number of control axes: 128	●	-	-	
	RD78GHW <small>Future release</small>	High-performance type, maximum number of control axes: 256	●	-	-	
Motion Control Software development kit MELSOFT EM78 SDK						
	SW1DND-EM78SDK-M <small>Future release</small>	PC-based Motion Control Software development kit (Motion Control Software SWM78, API library, EM Configurator2)	●	-	-	B
HMI GOT2000 Series						
	GT25-J71GN13-T2	CC-Link IE TSN communication unit Supported models: GT27, GT25*1	-	●	-	B
AC servos						
	MR-J5-G	MELSERVO-J5 series servo amplifier	-	-	●	B
	MR-J5W2-G	MELSERVO-J5 series 2-axis servo amplifier	-	-	●	
	MR-J5W3-G	MELSERVO-J5 series 3-axis servo amplifier	-	-	●	
Inverters						
	FR-A800-GN	FREQROL-A800 CC-Link IE TSN supported inverter	-	-	●	B
	FR-A8NCG	CC-Link IE TSN supported integrated option for FREQROL-A800 and FREQROL-F800 series	-	-	●	
Block type remote modules						
DC input	NZ2GN2S1-32D	32 points, 24 V DC, response time 0...70 ms, positive/negative common shared, spring-clamp terminal block, 1-wire	-	-	●	B
	NZ2GN2B1-32D	32 points, 24 V DC, response time 0...70 ms, positive/negative common shared, screw terminal block, 1-wire	-	-	●	
Transistor output	NZ2GN2S1-32T	32 points, 12/24 V DC (0.5 A), sink-type, spring-clamp terminal block, 1-wire	-	-	●	
	NZ2GN2S1-32TE	32 points, 12/24 V DC (0.5 A), source-type, spring-clamp terminal block, 1-wire	-	-	●	
	NZ2GN2B1-32T	32 points, 12/24 V DC (0.5 A), sink-type, screw terminal block, 1-wire	-	-	●	
I/O combined	NZ2GN2B1-32TE	32 points, 12/24 V DC (0.5 A), source-type, screw terminal block, 1-wire	-	-	●	
	NZ2GN2S1-32DT	Input: 16 points, 24 V DC, response time 0...70 ms, positive common Output: 16 points, 24 V DC (0.5 A), sink-type spring-clamp terminal block, 1-wire	-	-	●	
	NZ2GN2S1-32DTE	Input: 16 points, 24 V DC, response time 0...70 ms, negative common Output: 16 points, 24V DC (0.5 A), source-type spring-clamp terminal block, 1-wire	-	-	●	
	NZ2GN2B1-32DT	Input: 16 points, 24 V DC, response time 0...70 ms, positive common Output: 16 points, 24 V DC (0.5 A), sink-type screw terminal block, 1-wire	-	-	●	
Analog input	NZ2GN2S-60AD4	4 channels, input: -10...10 V DC, 0...20 mA DC, conversion speed: 200 μs/channel, spring-clamp terminal block	-	-	●	
	NZ2GN2B-60AD4	4 channels, input: -10...10 V DC, 0...20 mA DC, conversion speed: 200 μs/channel, screw terminal block	-	-	●	
Analog output	NZ2GN2S-60DA4	4 channels, output: -10...10 V DC, 0...20 mA DC, conversion speed: 200 μs/channel, spring-clamp terminal block	-	-	●	
	NZ2GN2B-60DA4	4 channels, output: -10...10 V DC, 0...20 mA DC, conversion speed: 200 μs/channel, screw terminal block	-	-	●	

*1. Not all GT25 models are supported.

Development kit

Type	Model	Outline	Certified Class
Master station software development kit <small>Future release</small>	SW1DTD-GNSDK1M*1	Library with source code provided, INtime version	*2
	SW1DTD-GNSDK2M*1	Library provided, INtime version	
Remote station software development kit	SW1DNC-GNSDK1S-M*1	Source code provided	*3
	SW1DNC-GNSDK2S-M*1	Source code provided, TCP/IP stack included*4	
Remote station communication LSI	NZ2GACP620-60	Communication LSI embedded with GbE-PHY (CP620) 60 pieces	*2
	NZ2GACP620-300	Communication LSI embedded with GbE-PHY (CP620) 300 pieces	

*1. Contract is necessary to purchase a software development kit (SDK). Please contact your local Mitsubishi Electric office or representative for further details.

*2. Can be used for development of certified Class B.

*3. Can be used for development of certified Class A.

*4. A separate license is necessary for the TCP/IP stack. Please contact your local Mitsubishi Electric office or representative for further details.

Android and Google Play are trademarks of Google Inc.
Apple, iPad, iPad Air, iPad mini, and App Store are trademarks of Apple Inc., registered in the U.S. and other countries.
Ethernet is a trademark of Xerox Corporation.
IOS is a trademark or registered trademark of Cisco in the U.S. and other countries and is used under license.
Microsoft and Windows are registered trademarks of Microsoft Corporation in the United States and other countries.
OPC UA logo and OPC CERTIFIED logo are registered trademarks of OPC Foundation.
The name PLCopen® is a registered trademark owned by the association PLCopen.
QR Code is a trademark or a registered trademark of DENSO WAVE INCORPORATED in JAPAN, the United States and/or other countries.
All other company names and product names used in this document are trademarks or registered trademarks of their respective companies.

Precautions before use

This publication explains the typical features and functions of the products herein and does not provide restrictions or other information related to usage and module combinations. Before using the products, always read the product user manuals. Mitsubishi Electric will not be held liable for damage caused by factors found not to be the cause of Mitsubishi Electric; opportunity loss or lost profits caused by faults in Mitsubishi Electric products; damage, secondary damage, or accident compensation, whether foreseeable or not, caused by special factors; damage to products other than Mitsubishi Electric products; or any other duties.

For safe use

- To use the products given in this publication properly, always read the relevant manuals before beginning operation.
- The products have been manufactured as general-purpose parts for general industries, and are not designed or manufactured to be incorporated in a device or system used in purposes related to human life.
- Before using the products for special purposes such as nuclear power, electric power, aerospace, medicine or passenger-carrying vehicles, consult with Mitsubishi Electric.
- The products have been manufactured under strict quality control. However, when installing the products where major accidents or losses could occur if the products fail, install appropriate backup or fail-safe functions in the system.

YOUR SOLUTION PARTNER

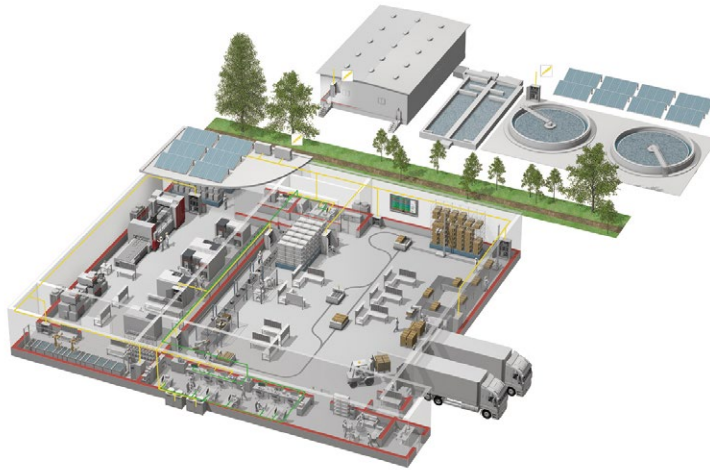

Mitsubishi Electric offers a wide range of automation equipment from PLCs and HMIs to CNC and EDM machines.

A NAME TO TRUST

Since its beginnings in 1870, some 45 companies use the Mitsubishi name, covering a spectrum of finance, commerce and industry.

The Mitsubishi brand name is recognized around the world as a symbol of premium quality.

Mitsubishi Electric Corporation is active in space development, transportation, semi-conductors, energy systems, communications and information processing, audio visual equipment and home electronics, building and energy management and automation systems, and has 237 factories and laboratories worldwide in over 121 countries.

This is why you can rely on Mitsubishi Electric automation solution - because we know first hand about the need for reliable, efficient, easy-to-use automation and control in our own factories.

As one of the world's leading companies with a global turnover of over 4 trillion Yen (over \$40 billion), employing over 100,000 people, Mitsubishi Electric has the resource and the commitment to deliver the ultimate in service and support as well as the best products.



Low voltage: MCCB, MCB, ACB



Medium voltage: VCB, VCC



Power monitoring, energy management



Compact and Modular Controllers



Inverters, Servos and Motors



Visualisation: HMIs



Numerical Control (NC)



Robots: SCARA, Articulated arm



Processing machines: EDM, Lasers, IDS



Transformers, Air conditioning, Photovoltaic systems

* Not all products are available in all countries.

Country/Region	Sales office	Tel/Fax
USA	MITSUBISHI ELECTRIC AUTOMATION, INC. 500 Corporate Woods Parkway, Vernon Hills, IL 60061, U.S.A.	Tel : +1-847-478-2100 Fax : +1-847-478-2253
Mexico	MITSUBISHI ELECTRIC AUTOMATION, INC. Mexico Branch Boulevard Miguel de Cervantes Saavedra 301, Torre Norte Piso 5, Ampliacion Granada, Miguel Hidalgo, Ciudad de Mexico, Mexico, C.P.115200	Tel : +52-55-3067-7512
Brazil	MITSUBISHI ELECTRIC DO BRASIL COMERCIO E SERVICOS LTDA. Avenida Adelino Cardana, 293, 21 andar, Bethaville, Barueri SP, Brasil	Tel : +55-11-4689-3000 Fax : +55-11-4689-3016
Germany	MITSUBISHI ELECTRIC EUROPE B.V. German Branch Mitsubishi-Electric-Platz 1, 40882 Ratingen, Germany	Tel : +49-2102-486-0 Fax : +49-2102-486-7780
UK	MITSUBISHI ELECTRIC EUROPE B.V. UK Branch Travellers Lane, UK-Hatfield, Hertfordshire, AL10 8XB, U.K.	Tel : +44-1707-28-8780 Fax : +44-1707-27-8695
Ireland	MITSUBISHI ELECTRIC EUROPE B.V. Irish Branch Westgate Business Park, Ballymount, Dublin 24, Ireland	Tel : +353-1-4198800 Fax : +353-1-4198890
Italy	MITSUBISHI ELECTRIC EUROPE B.V. Italian Branch Centro Direzionale Colleoni - Palazzo Sirio, Viale Colleoni 7, 20864 Agrate Brianza (MB), Italy	Tel : +39-039-60531 Fax : +39-039-6053-312
Spain	MITSUBISHI ELECTRIC EUROPE, B.V. Spanish Branch Carretera de Rubi, 76-80-Apdo. 420, E-08190 Sant Cugat del Valles (Barcelona), Spain	Tel : +34-935-65-3131 Fax : +34-935-89-1579
France	MITSUBISHI ELECTRIC EUROPE B.V. French Branch 25, Boulevard des Bouvets, 92741 Nanterre Cedex, France	Tel : +33-1-55-68-55-68 Fax : +33-1-55-68-57-57
Czech Republic	MITSUBISHI ELECTRIC EUROPE B.V. Czech Branch, Prague Office Pekarska 621/7, 155 00 Praha 5, Czech Republic	Tel : +420-255-719-200
Poland	MITSUBISHI ELECTRIC EUROPE B.V. Polish Branch ul. Krakowska 48, 32-083 Balice, Poland	Tel : +48-12-347-65-00
Sweden	MITSUBISHI ELECTRIC EUROPE B.V. (Scandinavia) Hedvig Mollersgata 6, 223 55 Lund, Sweden	Tel : +46-8-625-10-00 Fax : +46-46-39-70-18
Russia	MITSUBISHI ELECTRIC (RUSSIA) LLC St. Petersburg Branch Piskarevsky pr. 2, bld 2, lit "Sch", BC "Benua", office 720; 195027 St. Petersburg, Russia	Tel : +7-812-633-3497 Fax : +7-812-633-3499
Turkey	MITSUBISHI ELECTRIC TURKEY A.S Umraniye Branch Serifali Mahallesi Nutuk Sokak No:5, TR-34775 Umraniye/Istanbul, Turkey	Tel : +90-216-526-3990 Fax : +90-216-526-3995
UAE	MITSUBISHI ELECTRIC EUROPE B.V. Dubai Branch Dubai Silicon Oasis, P.O.BOX 341241, Dubai, U.A.E.	Tel : +971-4-3724716 Fax : +971-4-3724721
South Africa	ADROIT TECHNOLOGIES 20 Waterford Office Park, 189 Witkoppen Road, Fourways, South Africa	Tel : +27-11-658-8100 Fax : +27-11-658-8101
China	MITSUBISHI ELECTRIC AUTOMATION (CHINA) LTD. Mitsubishi Electric Automation Center, No.1386 Hongqiao Road, Shanghai, China	Tel : +86-21-2322-3030 Fax : +86-21-2322-3000
Taiwan	SETSUYO ENTERPRISE CO., LTD. 6F, No.105, Wugong 3rd Road, Wugu District, New Taipei City 24889, Taiwan	Tel : +886-2-2299-2499 Fax : +886-2-2299-2509
Korea	MITSUBISHI ELECTRIC AUTOMATION KOREA CO., LTD. 7F to 9F, Gangseo Hangang Xi-tower A, 401, Yangcheon-ro, Gangseo-Gu, Seoul 07528, Korea	Tel : +82-2-3660-9569 Fax : +82-2-3664-8372
Singapore	MITSUBISHI ELECTRIC ASIA PTE. LTD. 307 Alexandra Road, Mitsubishi Electric Building, Singapore 159943	Tel : +65-6473-2308 Fax : +65-6476-7439
Thailand	MITSUBISHI ELECTRIC FACTORY AUTOMATION (THAILAND) CO., LTD. 12th Floor, SV.City Building, Office Tower 1, No. 896/19 and 20 Rama 3 Road, Kwaeng Bangpongpan, Khet Yannawa, Bangkok 10120, Thailand	Tel : +66-2682-6522 Fax : +66-2682-6020
Vietnam	MITSUBISHI ELECTRIC VIETNAM COMPANY LIMITED Unit 01-04, 10th Floor, Vincom Center, 72 Le Thanh Ton Street, District 1, Ho Chi Minh City, Vietnam	Tel : +84-28-3910-5945 Fax : +84-28-3910-5947
Indonesia	PT. MITSUBISHI ELECTRIC INDONESIA Gedung Jaya 8th Floor, JL. MH. Thamrin No.12, Jakarta Pusat 10340, Indonesia	Tel : +62-21-31926461 Fax : +62-21-31923942
India	MITSUBISHI ELECTRIC INDIA PVT. LTD. Pune Branch Emerald House, EL-3, J Block, M.I.D.C., Bhosari, Pune-411026, Maharashtra, India	Tel : +91-20-2710-2000 Fax : +91-20-2710-2100
Australia	MITSUBISHI ELECTRIC AUSTRALIA PTY. LTD. 348 Victoria Road, P.O. Box 11, Rydalmere, N.S.W 2116, Australia	Tel : +61-2-9684-7777 Fax : +61-2-9684-7245

Mitsubishi Electric Corporation Nagoya Works is a factory certified for ISO 14001 (standards for environmental management systems) and ISO 9001 (standards for quality assurance management systems).

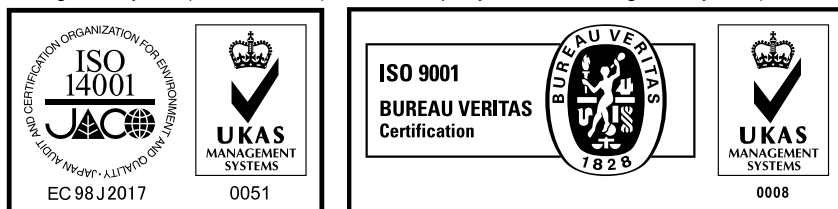

MITSUBISHI ELECTRIC CORPORATION

HEAD OFFICE: TOKYO BLDG., 2-7-3, MARUNOUCHI, CHIYODA-KU, TOKYO 100-8310, JAPAN
www.MitsubishiElectric.com